

Portable MP3-CD Player

EXP3460
EXP3461
EXP3462
EXP3463

User manual



PHILIPS

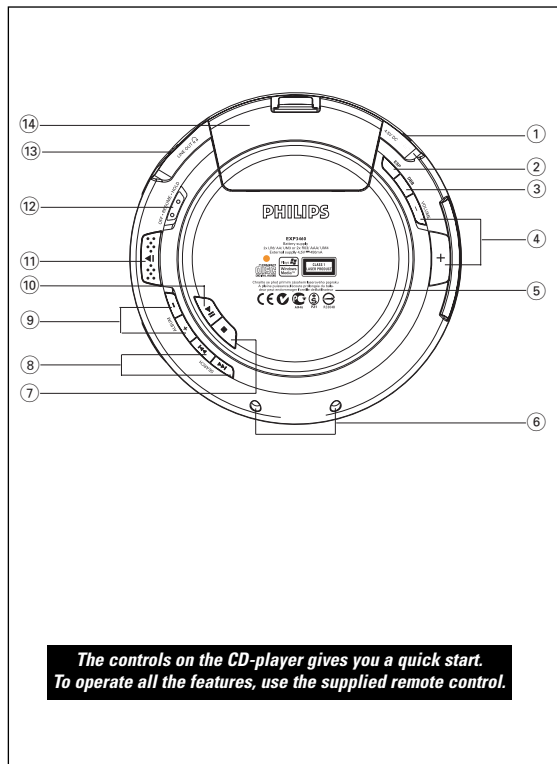

Meet Philips at the Internet
<http://www.philips.com>



EXP3460, EXP3461
EXP3462, EXP3463



Printed in China

AL/bk 445-1

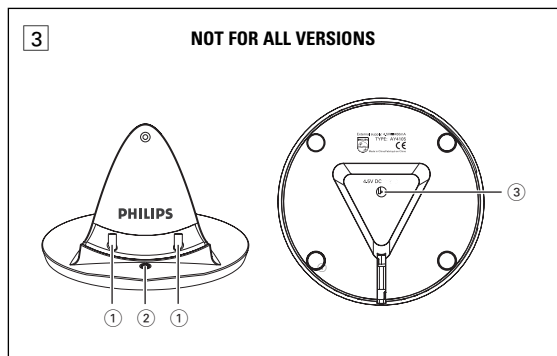
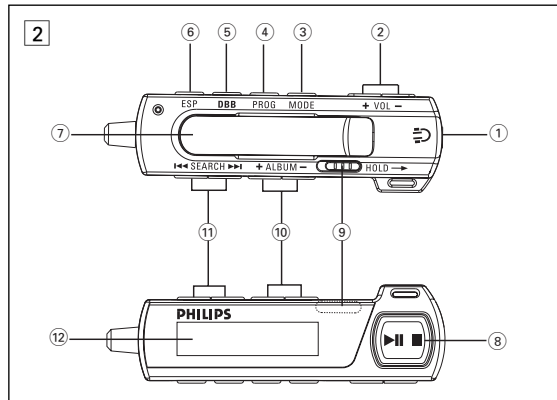

Supplied Accessories:

- 1 x headphones HE250
- 1 x remote control, AY3802
- 1 x AA battery door
- 1 x AC/DC adapter, AY3162 (for some versions only)
- 1 x charge cradle, AY4105 (for some versions only)
- 2 x rechargeable batteries AY3363 (for some versions only)

Controls (see figure 1)

- ① **4.5V DC** jack for AC/DC adapter power supply
- ② **ESP** selects between the battery powersave mode and Electronic Skip Protection (ESP). ESP prevents playback interruptions caused by shocks.
- ③ **DBB** switches the bass enhancement on/off. When pressed for more than 2 seconds, the button switches audible feedback (beep) on/off.
- ④ **VOLUME +/-** adjusts the volume
- ⑤ typeplate
- ⑥ **Docking jack** connects to the docking pins on your AY4105 charge cradle (for some versions only)
- ⑦ **■** stops playback/ clears programmed tracks / switches off the set.
- ⑧ **SEARCH**skips and searches backward/ forward tracks.
- ⑨ **ALBUM +/-**MP3/WMA- CD only: selects the next/previous album or skips forward/backward tracks.
- ⑩ **▶II** switches the player on, starts or pauses CD playback.
- ⑪ **▲** opens the CD lid
- ⑫ **OFF**switches RESUME and HOLD off (on the set only)
- RESUME**saves the last position played
- HOLD**locks all buttons (on the set only)
- ⑬ connect the remote control here and your headphones to the remote control
- ⑭ battery door

REMOTE CONTROL AY3802 / HEADPHONE HE 250**Using the remote control**

The remote control allows you to command all the functions on the player.

- 1** Firmly connect the remote control to **LINE OUT** on the set.
- 2** Firmly connect the headphones to the jack on the remote control.
- 3** On the remote control, press **▶II** to start playback.
- 4** Adjust the volume and sound on your remote control.
- 5** To stop playback, press **■**.
- 6** To switch off the CD player, press **■** again.

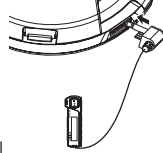
**Headphones HE250, LINE OUT**

- Connect the remote control to **LINE OUT** jack of the player and your headphones to the remote control.
- can also be used for connecting the player to your HiFi system.

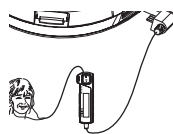
**IMPORTANT!**

Hearing safety: listen at a moderate volume. using headphones at high volume can impair your hearing.

Traffic safety: do not use headphones while driving or cycling as you may cause an accident.

This set complies with the radio interference requirements of the European Union.

Remote control AY3802 (see figure 2)

- ①3.5 mm headphone jack
- ② **VOL +/-**adjusts the volume
- ③ **MODE**selects playback options. To select and enter the display function, press and hold MODE for 3 seconds.
- ④ **PROG**programs tracks and reviews the program
- ⑤ **DBB**switches the bass enhancement on and off. When pressed for more than 2 seconds, the button switches audible feedback (beep) on/off.
- ⑥ **ESP**selects between the battery powersave mode and Electronic Skip Protection (ESP). ESP prevents playback interruptions caused by shocks.
- ⑦clip
- ⑧ **▶II**switches the player on, starts or pauses CD playback.
■stops CD playback, clears a program or switches the player off.
- ⑨ **OFF**switches HOLD off (on the remote control only)
HOLDlocks all buttons (on the remote control only)
- ⑩ **ALBUM +/-**MP3/WMA-CD only: selects the previous or next album
- ⑪ **SEARCH**skips and searches backward/ forward tracks
- ⑫display

Charge cradle AY4105 (see figure 3 , for some versions only)

- ① **Docking pins** connects to the docking jacks on your CDplayer
- ② **Charging indicator** lights up red/green for charging on/standby
- ③ **4.5V DC** jack for AC/DC adapter power supply

CD PLAYER AND CD HANDLING

- Do not touch the lens (A) of the CD player.
- Do not expose the unit, batteries or CDs to humidity, rain, sand or excessive heat (caused by heating equipment or direct sunlight).
- You can clean the CD player with a soft, slightly dampened, lint-free cloth. Do not use any cleaning agents as they may have a corrosive effect.
- To clean the CD, wipe it in a straight line from the center toward the edge using a soft, lint-free cloth. A cleaning agent may damage the disc! Never write on a CD or attach a sticker to it.
- The lens may cloud over when the unit is moved suddenly from cold to warm surroundings. Playing a CD is not possible then. Leave the CD player in a warm environment until the moisture has evaporated.
- Active mobile phones in the vicinity of the CD player may cause malfunctions.
- Avoid dropping the unit as this may cause damage.

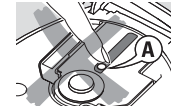
**CAUTION**

Use of controls or adjustments or performance of procedures other than herein may result in hazardous radiation exposure or other unsafe operation.

POWER SUPPLY

Batteries (supplied or optionally available)

You can use the following batteries with this CD-player:

- ◆ alkaline batteries type **AA (LR6, UM3)** or **AAA (LR03, UM4)**.
- ◆ PHILIPS rechargeable batteries, type **AY3363**

Inserting AA (LR6, UM3) batteries

- 1 Open the battery compartment.
- 2 Insert 2 x **AA** batteries as shown into the battery compartment.
- 3 Close the battery compartment.

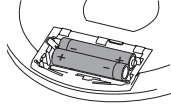

Inserting AAA (LR03, UM4) or AY 3363 batteries

- 1 Open the battery compartment.
- 2 Insert **AAA** batteries as shown onto the back of the AAA battery door.
- 3 Fit the **AAA** battery-loaded door onto the battery compartment.



Helpful Hints:

- Old and new or different types of batteries should not be combined.
- Remove batteries if they are empty or if the player is not going to be used for a long time.

Battery indication

The battery level is shown in the display screen as follows:



Battery full

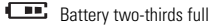

Battery two-thirds full

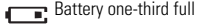

Battery one-third full



Battery dead or empty. The display shows **LOW BATT** and the beep tone sounds repeatedly.

POWER SUPPLY

Helpful Hint:

- Check that the player is switched off as it is not possible to charge batteries when the player is in use.
- It is normal for the batteries to become warm during recharging.
- To ensure proper recharging on the charge cradle, take care that contacts are clean.
- Use only the **ECO-PLUS NiMH** battery AY3363.

Handling instructions

- Recharging already charged or half-charged batteries will shorten their lifetime. We therefore recommend that you let the rechargeable **ECO-PLUS NiMH** battery run till it is completely empty before you recharge it.
- To avoid a short circuit, do not let the battery touch any metal object.
- If the battery becomes empty soon after recharging, then either its contacts are dirty or it has reached the end of its lifetime.

Batteries contain chemical substances, so they should be disposed of properly

- Apparatus shall not be exposed to dripping or splashing.
- Do not place any sources of danger on the apparatus (e.g. liquid filled objects, lighted candles)

POWER SUPPLY

Average playing time of batteries under normal conditions

Battery type	Audio CD	Power Save MP3-CD
Alkaline AA	30 hours	45 hours
Alkaline AAA	13 hours	20 hours

Charge cradle AY4105 (supplied or optionally available)

The AY4105 charge cradle can be used to charge batteries on board.

Recharging the ECO-PLUS NiMH battery on board the charge cradle

- 1 Connecting AY4105 charge cradle:
 - Make sure the local voltage corresponds to the the AC/DC adapter's voltage.
 - Connect the AC/DC adapter to the 4.5V DC jack of the charge cradle and to the wall outlet.
 - 2 Insert the rechargeable **ECO-PLUS NiMH** battery **AY3363**:
 - Check the batteries are correctly loaded.
 - 3 Mounting the CD player:
 - Check that the player is switched off.
 - As shown, ▼ facing the charging indicator, carefully slot the player onto the charge cradle. Make sure you align the player's docking jack to the docking pins.
- The charging indicator lights up red (for charging on) and charging starts.
- The display shows: **CHARGING**
- If the batteries become too warm, recharging will be interrupted for approximately 30 minutes and the display shows: **BATT HOT**
- When the batteries are fully recharged, the charging indicator turns green (for charging stand-by) and **BATT FULL** appears in the display

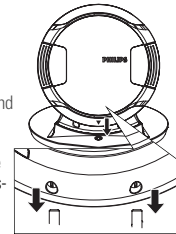
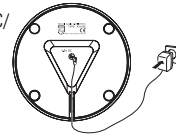

POWER SUPPLY

AC/DC adapter AY3162 (supplied or optionally available)

Only use AY3162 adapter (4.5V/450mA DC, positive pole to the center pin). Any other product may damage the player.

- 1 Make sure the local voltage corresponds to the AC/DC adapter's voltage.
- 2 Connect the AC/DC adapter to the 4.5V DC jack of the player and to the wall outlet.

Helpful Hint:

- Always disconnect the adapter when you are not using it.

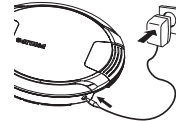

ENVIRONMENTAL INFORMATION

- All redundant packing material has been omitted. We have done our utmost to make the packaging easily separable into two materials: cardboard (box) and polyethylene (bags, protective foam sheet).
- Your set consists of materials which can be recycled if disassembled by a specialized company. Please observe the local regulations regarding the disposal of packing materials, dead batteries and old equipment.

ABOUT MP3/ WMA

The music compression technology MP3 (MPEG1 Audio Layer 3) and WMA (Windows Media Audio) significantly reduce the digital data of an audio CD while maintaining CD quality sound.

- **Getting MP3/WMA files:** you can either download legal music files from the internet to your computer hard disc, or create such files by converting audio CD files in your computer through appropriate encoder software. (128kbps bit is recommended for MP3 files and 96 kbps bit rate for WMA files.)
- **Creating a MP3/WMA CD:** burn the music files from your computer hard disc on a CDR or CDRW using your CD burner.

Helpful Hint:

- Make sure that the file names of the MP3 files end with .mp3 and WMA files and with .wma.
- Total number of music files and albums: around 350 (with a typical file length of 20 characters)
- The length of file names affects the number of tracks for playback. With short file names, more files can be burned on a disc.

Windows Media Audio® is a registered trademark of Microsoft Corporation.

All trademarks used are owned by their respective owners.

PLAYING A CD

With this set you can play

- all pre-recorded audio CDs (CDDA)

Important: CDs encoded with **copyright protection technologies** by some record companies may be unplayable by this product.

- all finalized audio CDRs and CDRWs
- WMA/MP3-CDs (CD-ROMs with WMA/MP3 files)

- 1 Push the open  slider to open the CD lid.
- 2 Insert a disc, printed side up, by pressing gently on the disc's center so that it fits onto the hub. Close the lid by pressing it down.

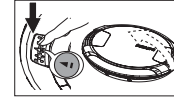

- 3 Press  to switch the player on and start playback.
→ Display shows **EXPANIUM** and also "READING CD" if the reading time exceed 5 seconds, e.g. MP3/WMA-CD). Then, Audio CD: current track number appears. MP3/WMA: Current file name appears.

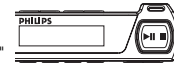

- 4 Press  briefly to interrupt playback.
→ The time where playback was interrupted blinks. Beep sounds at intervals.



- 5 To resume playback press  briefly again.



- 6 Press  to stop playback.
→ Audio CD: total playing time and total number of tracks appear. MP3/WMA: total number of albums/tracks appear.

PLAYING A CD

Helpful Hint:

- When playing a disc with CD Audio tracks and MP3 files, the CD Audio tracks will be played first.

- "0" is shown as your album number, if you have not organized your MP3/WMA files into any albums on your disc.

- 7 Press  again to switch off the CD player.

- 8 To remove the disc, hold it by its edge and press the hub gently while lifting the disc.

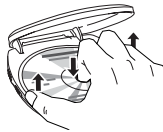

Auto-standby

When a CD has reached the end of playback and remains in the stop position for more than 25 seconds, the display will disappear. 65 seconds later, the set will automatically switch off to save mains.

VOLUME AND SOUND

Volume adjustment

- Adjust the volume by pressing **VOLUME +/-** (00 - 30, or **VOL +/-** on the remote control).





Helpful Hint:

Volume level resumes at:

- Default level 12: when starting playback from standby/power off mode.
- Previous level: when starting playback from the stop position.

Bass adjustment

There are three DBB (Dynamic Bass Boost) options:

- Off: no bass enhancement
-  : moderate bass enhancement
-  : strong bass enhancement
- Press DBB once or more to select your option.
→  appears if DBB activated.

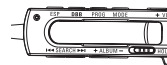

SELECTING A TRACK/ ALBUM AND SEARCHING

Selecting and searching on all discs

Selecting a track

- Briefly press **◀◀** or **▶▶** once or several times to skip to the beginning of the current, previous or subsequent track.
- In the pause/stop position, press **▶▶** to start playback. → Playback continues with the selected track.

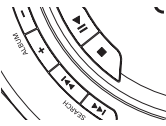

Searching for a passage during playback

- 1 Keep **◀◀** or **▶▶** pressed to find a particular passage in backward or forward direction. → Searching starts and playback continues at a low volume.
- 2 Release the button at the desired passage. → Normal playback continues.

Selecting on WMA/MP3-CDs

Selecting an album

- Briefly press **ALBUM +/-** once or several times to skip to the first track of the subsequent, current or previous album.
- In the pause/stop position, press **▶▶** to start playback. → The first track of the selected album is played.



Selecting a track

- 1 Keep **ALBUM +/-** pressed to skip quickly to the subsequent, current or previous MP3/ WMA tracks. → Skipping starts and speeds up after 5 seconds.
- 2 Release the button at the desired track. → Playback continues with the selected track.

Helpful Hint:

– When the program mode is active, use of the **ALBUM +/-** keys are void.

PROGRAMMING TRACK NUMBERS

(remote control only)

You can select up to 50 tracks and store them in the memory in a desired sequence. You can store any track more than once.

- 1 Select a track with **◀◀** or **▶▶** (and also **ALBUM +/-** for a MP3/WMA-CD).
- 2 On the remote control, press **PROG** to store the track. → **P** with the number of stored tracks is displayed.
- 3 Select and store all desired tracks in this way.
- 4 If necessary, press **■** to stop normal playback. Press and hold **▶▶** briefly to start playback of the program. → **PROG** is shown and playback of the program starts.



- 5 To add additional tracks to your program, press **■** to stop playing the program and continue with step 1 and 2. → After 50 tracks are stored, **PROG FULL** is shown.

Reviewing the program

You can review the programme by pressing **PROG** for more than 3 seconds. → All stored tracks are displayed in sequence.

Clearing the program

- 1 If necessary press **■** to stop playback.
- 2 Press **■** to clear the program. → **Cleared** is displayed.

Helpful Hint:

– The program will also be cleared if you interrupt the power supply or open the CD lid or if the set switches off automatically.

SELECTING DIFFERENT PLAY OPTIONS – MODE

(remote control only)

You can select and change the various play modes before or during playback.

- 1 On the remote control, press **MODE** repeatedly to select any of the following:
 - **ALL** (**Shuffle All**): all tracks of the disc play in random order once.
 - **ALL** (**Shuffle repeat all**): all tracks of the disc play in random order repeatedly.
 - **1** (**Repeat 1**): the current track plays repeatedly.
 - **ALL** (**Repeat All**): all tracks of the disc/ program play repeatedly.
 - **Scan All** : each track in the disc/program plays 10 seconds in sequence.

For MP3/WMA-CDs only:

- (**Shuffle Album**): all tracks of current album play in random order once.
 - (**Shuffle Repeat Album**): all tracks of current album play in random order repeatedly.
 - (**Repeat Album**): all tracks of current album play repeatedly.
- The play mode is selected after its icon flashes 3 times.
- 2 Press **▶▶** to start playback if in the stop position.
 - 3 To return to normal playback, press **MODE** repeatedly until the play option icons e.g. and disappear.

Helpful Hint:

– , , **Scan All** : only these play modes can be combined with programmed tracks.

DISPLAY INFORMATION

(WMA/MP3 tracks only)

- On the remote control, press and hold **MODE** 3 seconds to activate the display option mode. Within 2 seconds, press **MODE** briefly again, once or more to change and select your display option:
 - **FILE NAME** : the track's file name
 - **ALBUM** : the album's folder name
 - **TITLE** : the track's title (if this ID3 tag information is available)
 - **ARTIST** : the artist's name (if this ID3 tag information is available)
 - **PLAY TIME** : the album number, elapsed playing time, and track number.

Helpful Hint:

- The ID3 tag is part of an WMA/MP3 file and contains various track information such as the track's title or the artist's name. Complete the ID3 tag information with your MP3 encoder software before burning the WMA/MP3-CD.
- The display can show a maximum of 31 characters.

ESP / POWERSAVING MODE

With a conventional portable CD-player you might have experienced that the music stopped e.g. when you were jogging. The **Electronic Skip Protection (ESP)** prevents loss of sound caused by light vibrations and shocks. Continuous playback is ensured. However ESP does not prevent playback interruptions during vigorous running. **It also does not protect the unit against any damage caused by dropping!**

The power save mode helps to extend battery service life for longer playback.

- To deactivate the shock protection and enter the power save mode, press **ESP**.
→ **ESP** disappears.
- Press **ESP** again.
→ **ESP** appears when shock protection is activated
→ **Oops**: maximum **ESP** time exceeded. Playback skips but will resume optimum playback when the player is free from vibration.



200 SEC MAGIC ESP

Average playing times when ESP protection is activated:

Seconds	track type
200	WMA-CD(64kbps)
100	MP3-CD(128kbps)
45	Audio CD

Helpful Hint:

- *ESP is by default activated.*

HOLD

- To deactivate HOLD, switch the slider to **OFF**.
→ All the buttons are unlocked.

Helpful Hint:

- *If you deactivate HOLD by switching the slider on the set to RESUME, you will be activating the RESUME function.*

ACOUSTIC FEEDBACK (BEEP)

Acoustic feedback is a beep signal that is heard when buttons on the set or remote control are pressed. Also, when the set or remote control is in pause mode or the battery power is low, it beeps at intervals.

- 1 Keep **DBB** pressed for more than 2 seconds to switch the beep either off or on.
→ **beep off** : Beep is switched off.
→ **beep on** : Beep is switched on.

Helpful Hint:

- *Beep is on as the default setting.*

RESUME

(main set only, audio CD only)

RESUME - continuing from where you have stopped

You can store the last position played. When restarting, playback will continue from where you have stopped (RESUME). Use the **OFF-RESUME-HOLD** slider on the set for this function.

- 1 Switch the slider to **RESUME** during playback to activate RESUME.
 - 2 Press **■** whenever you want to stop playback.
 - 3 Press **▶II** whenever you want to resume playback (or on the remote control, press and hold **▶II** briefly).
→ Playback continues from where you have stopped.
- To deactivate RESUME, switch the slider to **OFF**.



HOLD

HOLD - locking all buttons

This player offers a double lock function to prevent buttons from being accidentally pressed and activated. You can choose to lock all buttons on either your set, remote control or even both! Simply adjust the respective **HOLD** slider to on or off position as desired. For example:

- Switch the **OFF-RESUME-HOLD** slider to **HOLD** to activate HOLD (or on the remote control, switch the **OFF-HOLD** slider to **HOLD**).

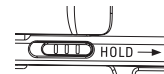

- All buttons are locked. **HOLD** is shown when you press any button on the set / remote control respectively. If the set is locked and switched off, **HOLD** will be shown only when you press **▶II**.



TROUBLESHOOTING

WARNING: Under no circumstances should you try to repair the unit yourself as this will invalidate the warranty. If a fault occurs, first check the points listed, before taking the unit for repair. If you are unable to solve a problem by following these hints, consult your dealer or service center.

The CD player has no power, or playback does not start

- Check that your batteries are not dead or empty, that they are inserted correctly, that the contact pins are clean.
- Your adapter connection may be loose. Connect it securely.

The indication **Insert CD** is displayed

- Check that the CD is clean and correctly inserted (label-side upward).
- If your lens has steamed up, wait a few minutes for this to clear.
- Make sure the CD is not encoded with **Copyright protection technologies**, as some do not conform to the Compact Disc standard.

The indication **Disc Error** is displayed

- CD-RW (CD-R) was not recorded properly. Use **FINALIZE** on your CD-recorder.

The indication **Non audio** is displayed

- CD contains non-audio files. Insert a suitable disc or press **SEARCH** **◀◀** / **▶▶** once or more to skip to an audio track, instead of the data file.

The indication **HOLD** is on and/or there is no reaction to controls

- If **HOLD** is activated, then deactivate it.
- Electrostatic discharge. Disconnect power or remove batteries for a few seconds.

The CD skips tracks

- The CD is damaged or dirty. Replace or clean the CD.
- **SHUFFLE** or **PROG** is active. Switch off whichever is on.

No sound or bad sound quality.

- pause might be active. Press **▶II**.
- Loose, wrong or dirty connections. Check and clean connections.
- Volume might not be appropriately adjusted. Adjust the volume.
- Strong magnetic fields. Check player's position and connections. Also keep away from active mobile phones.

